



# Combined refrigerated and heating bath circulator

ecocool 150R

Operating Manual

If you have any feedback on Grant's products or services, we would like to hear from you.  
Please send all feedback to:

Quality Manager  
Grant Instruments (Cambridge) Ltd  
Shepreth  
Cambridgeshire  
SG8 6GB  
UK

Tel: +44 (0) 1763 260 811  
E-mail: [support@grantinstruments.com](mailto:support@grantinstruments.com)

Sales  
Tel: +44 (0) 1763 264 741  
E-mail: [salesdesk@grantinstruments.com](mailto:salesdesk@grantinstruments.com)

**Representative in the European Union**

Grant Instruments Europe B.V.  
Strawinskylaan 411  
WTC, Tower A 4th Floor  
1077 XX AMSTERDAM  
THE NETHERLANDS

Email: [grant@eu.grantinstruments.com](mailto:grant@eu.grantinstruments.com)

# Contents

---

Contents	2
1.0 Use of products	4
2.0 How to use this operating manual	4
3.0 Safety information	4
3.1 Safety compliance	4
3.2 Safety symbols	4
3.3 Safety warnings	5
4.0 Operating instructions	6
4.1 Unpacking instructions	6
4.2 Product description	7
4.2.1 Heating circulator	7
4.2.2 Refrigerated bath	10
4.3 Installation	13
4.4 Rotating the heating circulator	13
4.5 Fitting the communications lead	13
4.6 Electrical supply	13
4.7 Recommended liquids	14
5.0 Operating procedures	16
5.1 Preparing the ecocool 150R for use	16
5.1.1 Liquid level	16
5.1.2 Tank lid	16
5.1.3 Setting the over-temperature thermostat	16
5.1.4 Using the heating circulator pump	17
5.1.5 Using the switch over relay output	18
5.1.6 Emptying the liquid tank	18
5.1.7 Setting up and switching on	19
5.1.8 Eco mode cooling	19
5.2 Using the equipment controls	20
5.2.1 Setting the control temperature	20
5.2.2 Setting a pump speed	20
5.2.3 Running a bath preset	20
5.2.4 Running a countdown timer	21
5.2.5 Running a program	21
5.2.6 Activating standby mode	22
5.2.7 Accessing the settings menu	23
5.3 Viewing, editing and saving settings	24
5.3.1 Configuring a preset	24
5.3.2 Setting the cooling mode	25
5.3.3 Switching on the external pump	25
5.3.4 Selecting a liquid type	26
5.3.5 Selecting a temperature probe type	28
5.3.6 Configuring high and low temperature alarms	29
5.3.7 Setting the buzzer volume level	32
5.3.8 Selecting a language	32
5.3.9 Relay test and configuration	33
5.3.10 Display rounding	34
5.4 Completing a calibration	35
5.4.1 Restoring factory calibration settings	37
6.0 Technical specifications	38
6.1 Operating conditions	38
6.2 Electrical details	38
6.3 Performance	38
6.4 Storage and transportation	38

7.0	Technical Tips	39
7.1	Which water should you use in your equipment tank?	39
7.2	How to prevent rust in the equipment tanks	39
7.3	How to prevent algae and bacteria?	40
8.0	Warranty information	40
9.0	Maintenance and service	41
9.1	Routine maintenance	41
9.2	Cleaning	41
9.3	Fuses	42
9.5	Routine safety tests	42
9.7	Service	43
10.0	Optional accessories	44
10.1	Alternative pump	44
10.2	Pump connectors and other accessories	44
11.0	Troubleshooting	46
12.0	Contact Grant Instruments	49
13.0	Compliance	49
	Notes	50



## 1.0 Use of products

---

The following products are covered by this operating manual:

- ecocool 150R
- ecocool 150R US

The product is a combined refrigerated and heating bath circulator designed for indoor laboratory use by or supervised by a professional user.

The ecocool 150R system (*the equipment*) consists of a T ecocool 150R (*the heating circulator*) combined with an R ecocool 150R (*the refrigerated bath*). Both parts of the system are designed to work together and will not work independently or with other heating and refrigeration models.

The included insulated hoses and clips allow circulation of temperature control fluids to external equipment.

## 2.0 How to use this operating manual

---

This operating manual will allow you to unpack, set-up and operate this refrigerated and heating bath circulator correctly and safely. Important safety information, symbols and warnings are listed below and should be read carefully before operating the product. Section 4 gives information about how to unpack and install the product correctly. Section 5 gives operating information for the equipment. Product technical specifications and tips are provided in sections 6 and 7. The warranty for this product is for THREE YEARS and should be registered by completing the on-line registration form which can be found at [www.grantinstruments.com](http://www.grantinstruments.com). Full details of warranty conditions can be found in section 8 of this manual

If you have any questions regarding the operation of the equipment, please contact your local distributor or Grant instruments who will be able to assist you with your enquiry.

## 3.0 Safety information

---

### 3.1 Safety compliance

The equipment meets the requirements of international safety standard IEC 61010: Safety requirements for electrical equipment for measurement, control, and laboratory use.

### 3.2 Safety symbols

The symbols below are marked on the equipment and throughout this manual to indicate:



Caution: Surface(s) and heat transfer liquid can be hot during and after use.



Read these instructions before installation or use of the ecocool 150R (*the equipment*)



Warning, hazard: read these instructions before proceeding to ensure you understand the nature of the hazard.



Warning: equipment contains a flammable refrigerant.

### 3.3 Safety warnings



Use only as specified by the operating instructions: if the equipment is used in a manner not specified by the manufacturer, the protection provided by the equipment may be impaired.



This equipment is only for indoor use by or supervised by a professional user.



Use only water, water-glycol, or silicone oil with this equipment (see section 4.7 for more details). Do not inhale the vapours given off as they may be toxic. Liquids should be safely discarded and replaced.



Make sure the correct fluid type has been selected in the heating circulator and ensure that the fluid is only used within its specified temperature range.



Do not use the equipment with any sample material that could cause a fire or any other kind of hazard.



Do not use the equipment in an area where there are aggressive or explosive chemical mixtures.



It is the user organisation's responsibility to carry out appropriate decontamination if hazardous material is spilt on the equipment.



Before moving, disconnect from the mains power supply.



If a warning message or warning light appears on the heating circulator display, do not touch the liquid or the tank, they may be very hot.



Do not touch surfaces which become hot during high temperature operation.



It is the user organisation's responsibility to carry out a risk assessment when operating this product within their operating environment.



**WARNING:** Do not use mechanical devices or other means to accelerate defrosting: either turn the equipment off or set it to ambient temperature and wait until all the ice has melted.



**WARNING:** Do not damage the refrigerant circuit.

## 4.0 Operating instructions

---

### 4.1 Unpacking instructions

Standard equipment includes:

- ecocool 150R refrigerated bath and heating circulator
- Ready to use 2 metre insulated hose kit - for use up to 100°C
- 2 additional hose clips
- Mains cord with plug
- Mains link-cord for heating circulator - 230V equipment only
- Communications lead
- Safety information sheet



The equipment weighs 24 kg. Take necessary precautions when moving and lifting.

Remove packing materials carefully and retain them for future shipment or storage of the equipment.

## 4.2 Product description

### 4.2.1 Heating circulator

Figure 1: Heating circulator front panel

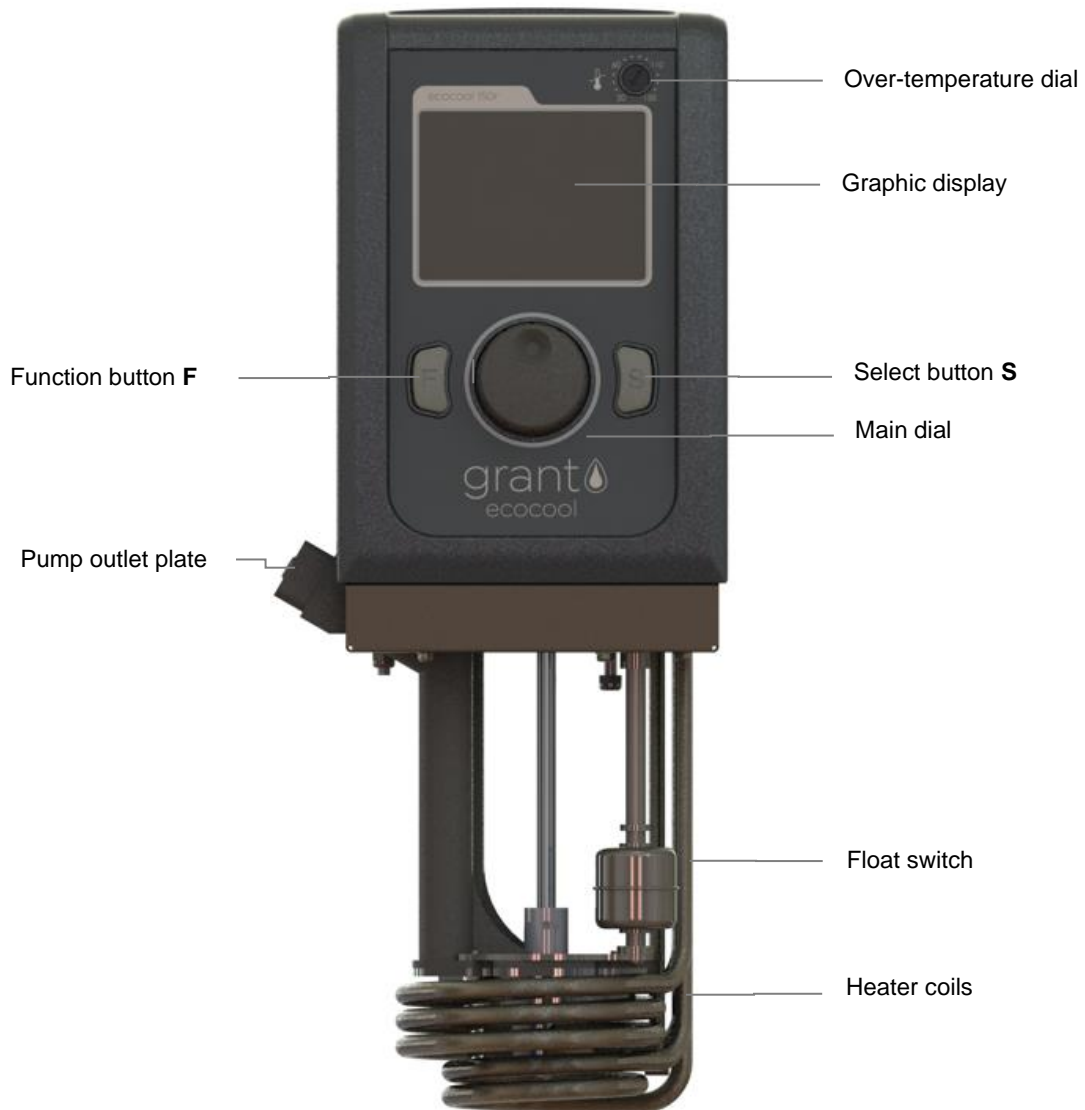

The heating circulator features a full colour graphic display, a main dial and two buttons **F** and **S**. All functions (setting temperature, pump speed, countdown timer, presets, programs settings and standby mode) can be configured from the home screen.

Navigation around the home screen is achieved by rotating the main dial which moves a white cursor to highlight function icons.

Pressing the **S** button whilst the icon is highlighted will change the colour of the cursor to red, make the icon active and allow changes to be made, or in the case of the settings icon, further menus to be displayed.

The primary function of the **F** button is to exit functions and menus. If **F** is pressed when in the home screen whilst the cursor is white the settings menu is displayed

## Explanation of home screen icons.

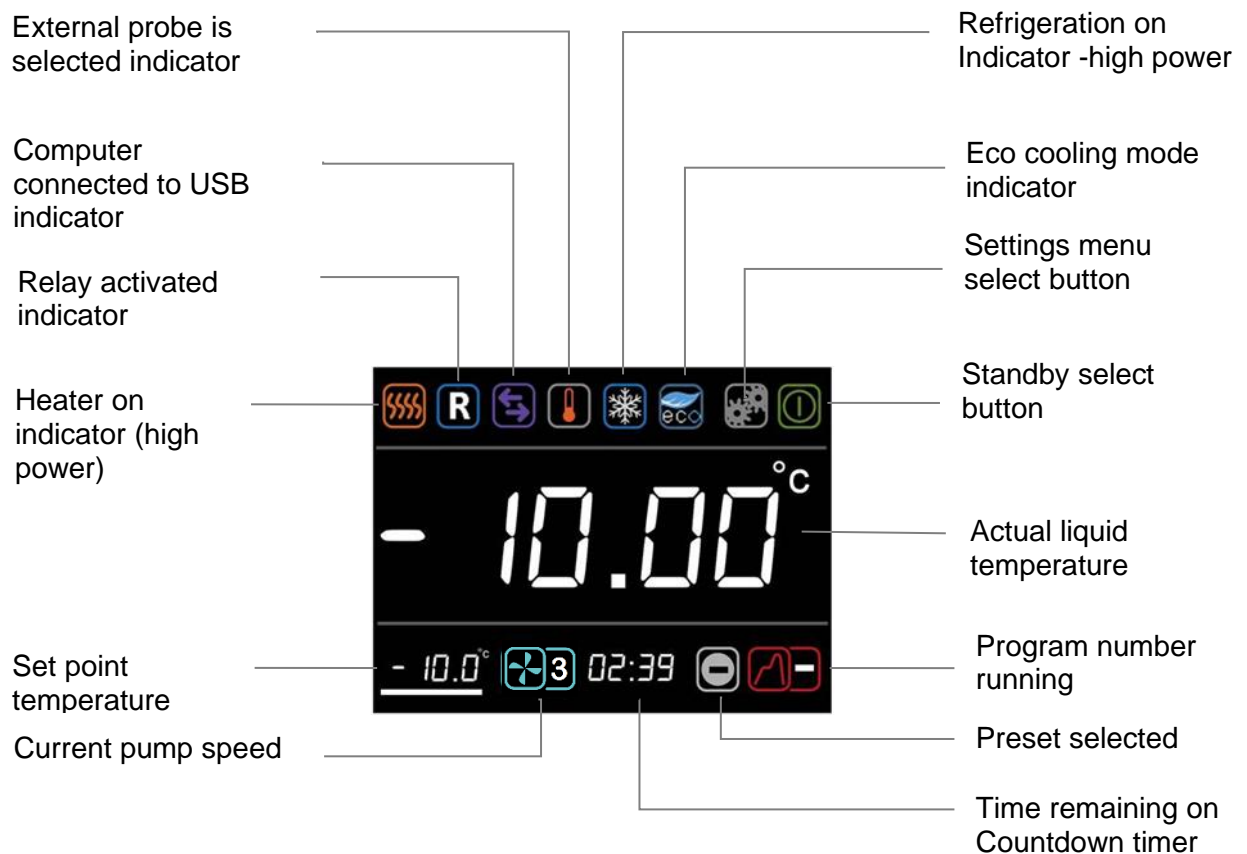

Navigation around the home screen is achieved by rotating the main dial which moves a white cursor to highlight function icons. Pressing the **S** button whilst the icon is highlighted will change the colour of the cursor to red, make the icon active and allow changes to be made, or in the case of the settings icon, further menus to be displayed. Press the **F** button to cancel an active icon. The cursor will then change to white.

Pressing the **F** button on any function icon whilst the cursor is white is a shortcut to the settings menu.

Indicator icons are visible if the feature they represent is currently active. They cannot be selected using the cursor.

The Heater and Chiller icons can show 2 different modes

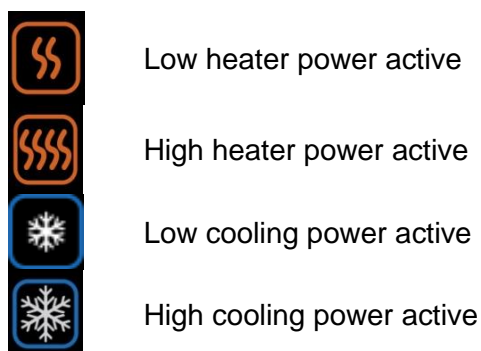

If the heater or chiller icons are not visible then they are not active

**Figure 2: Heating circulator rear panel**

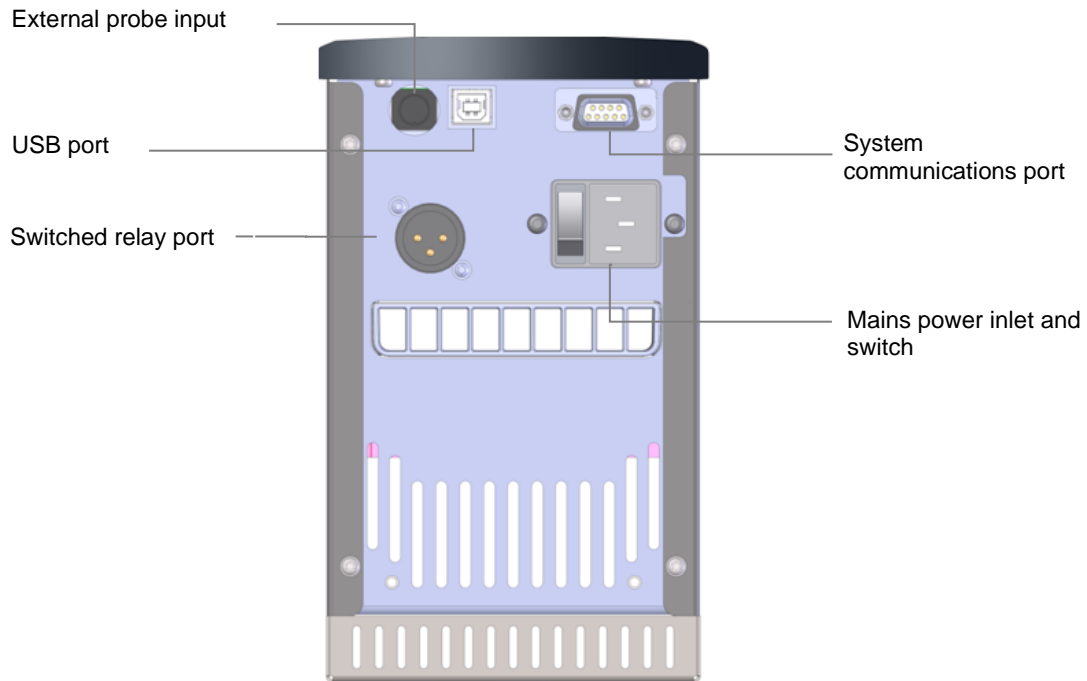

### **System Communications port**

The system communications port provides communications between the heating circulator and refrigerated bath. The communications cable should remain connected at all times.

Only use the communications port cable supplied with the system. Do not connect anything else to this communication port

### **USB Port**

The heating circulator provides a USB data port for communication with a PC running Grant Labwise™ software. Labwise™ provides the ability to remotely configure, control, monitor programs as well as log program temperature data.

The USB cable is a Type A to Type B style.

### **Switched relay port**

An internal relay provides switch over contacts that can be used to control external equipment. See Section 5.1.5 for details of the relay contacts and connector type.

### **External probe input**

An external PT1000 thermocouple temperature probe is available from Grant instruments.

This enables temperature control based on the temperature at a different location within the user's system. For further advice on the use of external temperature contact Grant Instruments

### **Mains Power cable inlet and switch**

For connection to the mains power outlet on the refrigerated bath on 230V equipment. Use the mains link-cord supplied with the system. For 120V units there is a fixed mains cable with plug fitted for connection directly to a mains power outlet.

## 4.2.2 Refrigerated bath

Figure 3: Refrigerated bath front panel (grille removed)

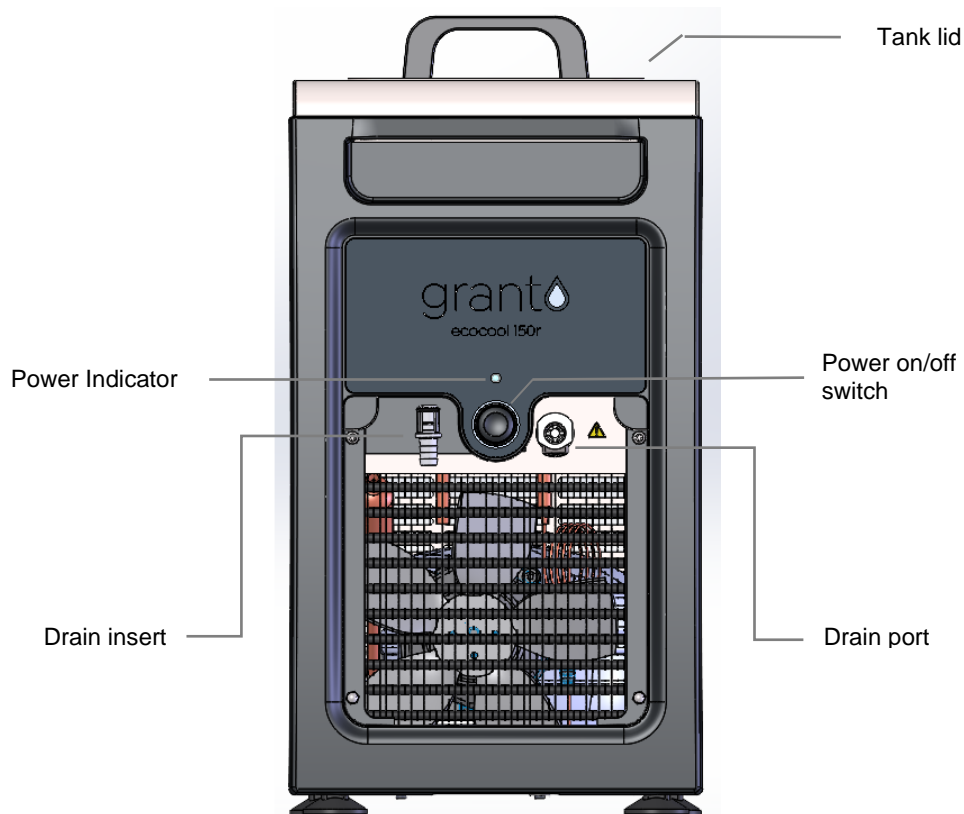

### Drain port and drain insert

To access the drain port, pull out the top of the front grille and lift away.

The drain port and insert allow the refrigerated bath to be emptied easily. To drain the refrigerated bath, first remove the drain insert from the holder and connect a suitable length of hosing to the drain insert. Have the non-connected end of tubing in a receptacle, suitable for the liquid to be drained. Push the drain insert into the drain port and let the liquid drain. To release the drain insert push up the grey button on the drain port and extract the drain insert.



Liquid to be drained should not be below 10°C or above 50°C.

Although the drain has been designed for minimum leakage it is advisable to place an absorbent cloth under the drain port to catch any drips.

Always replace the front grille after draining.

### Power on/off switch and indicator

Push switch to power on and off the equipment. Blue LED will indicator power on.

**Figure 4: Refrigerated bath rear panel**

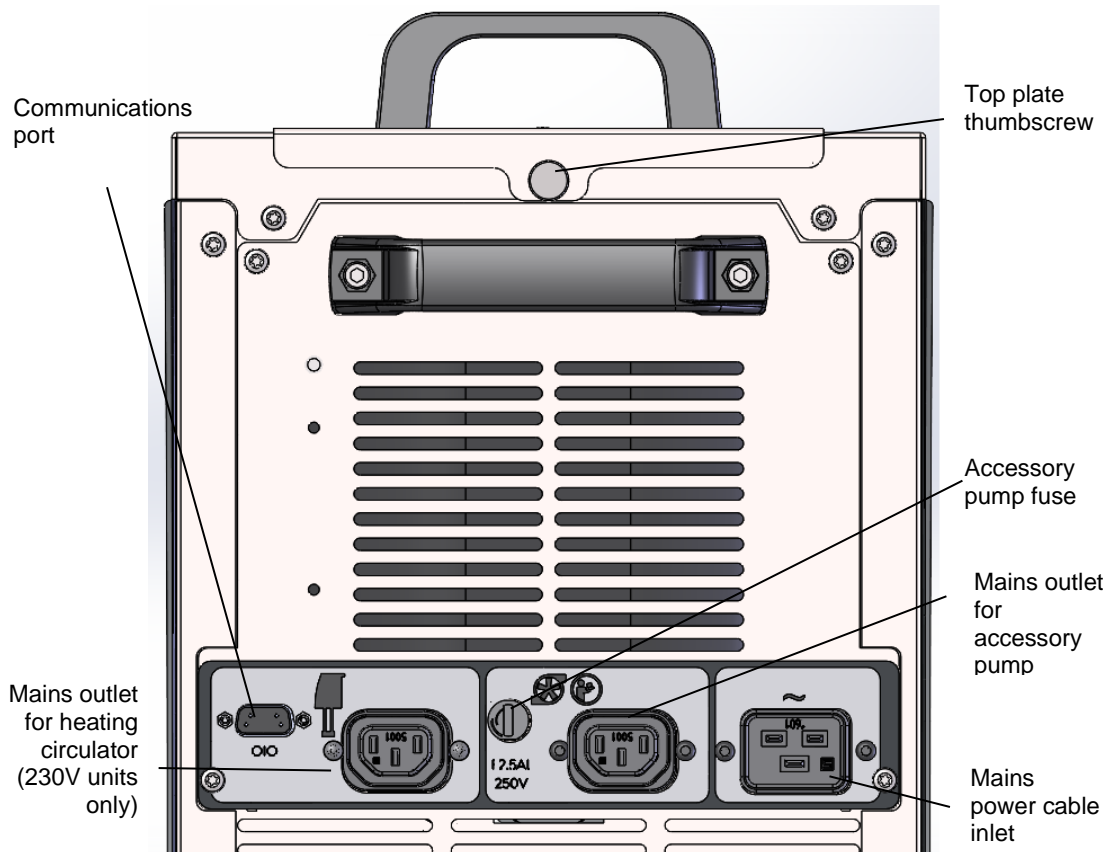

**Figure 5 Refrigerated bath rear connection panel (120V)**

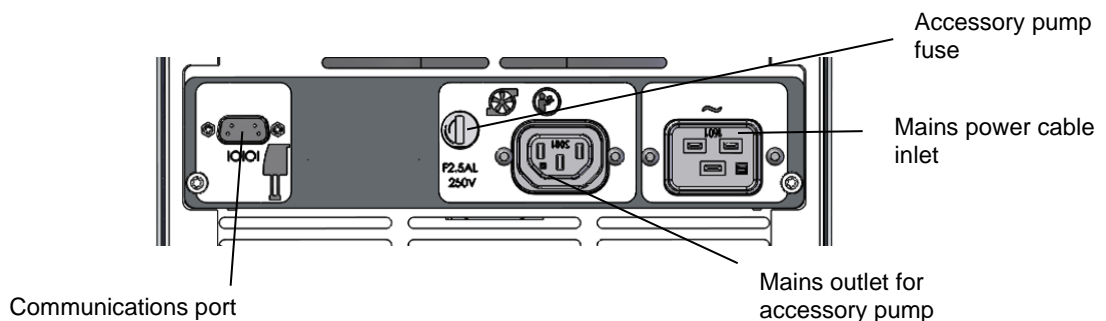

**Communications Port**

The system communications port provides communications between the heating circulator and refrigerated bath. The communications cable should remain connected at all times.

Only use the communications port cable supplied with the system. Do not connect anything else to this communication port

**Mains power outlet for heating circulator (230V units only)**

Provides power for 230V heating circulator. Use the mains link cord supplied with the equipment.

For 120V units, the heating circulator must be powered separately



**Mains power outlet for accessory pump**

Power connection for an optional accessory pump. Power can be set ON using the Settings menu. See section 5.3.3

**Mains power cable inlet**

For connection to a mains power supply. Use the mains cord supplied with the system. See Section 4.6 for instructions

**Top plate thumbscrew**

To remove the heating circulator from the bath for cleaning, first unfasten this thumbscrew. Slide the top plate backwards and lift to completely remove the heating circulator.

### 4.3 Installation

After transportation, let the equipment stand in its intended working position for six hours. This is to allow the oil to drain to the bottom of the compressor. This is normal procedure for refrigeration compressors.

Allow at least 100mm clearance from obstructions at the front and rear so that there is free air flow through the equipment.



Place the equipment on a firm, level surface. Ensure that the mains plug and the switch at the rear of the equipment are easily accessible.



After transport or storage in humid conditions, always allow the equipment to stand for at least an hour at room temperature before operating.



Do not block or restrict ventilation slots. Allow at least 100mm clearance from obstructions



Do not connect to a power supply or switch on before filling the tank.



Drain before moving the equipment. Liquid to be drained should not be below 10°C or above 50°C.



Always operate the equipment with the condenser grille fitted.

### 4.4 Rotating the heating circulator

The heating circulator is fitted ready to use with the pump ports facing the left-hand side. If required, the heating circulator can be rotated so the pump ports face the rear and the user controls are accessed from the left hand side.

Consider rotating the heating circulator, if following a risk assessment, access to hot surfaces needs to be reduced.

To rotate, remove the thumbscrew at the rear of the refrigerated bath and lift up the heating circulator and top plate. Remove the 2 thumbscrews from the underside of the top plate to release the heating circulator. Rotate the heating circulator on the top plate and refit.

### 4.5 Fitting the communications lead

Connect the communications lead from the heating circulator to the refrigerated bath. The connecting ports are shown in Section 4.2.1 (Figure 2), and 4.2.2 (figures 4 & 5). This enables the heating circulator to control the cooling power. If the lead is not connected correctly, the heating circulator will display the fault 'Check the refrigeration unit'.

### 4.6 Electrical supply



Connect the equipment to a grounded (earthed) electrical power supply with voltage and frequency within the range specified on the serial number plate.



The equipment must only be connected to the mains using the mains cord supplied or one with an identical rating (see section 9.4)



Ensure the mains switch and isolating device (power supply connector) is easily accessible during use.

The method of connection of 230V equipment and 120V equipment differs: on 230V equipment, the heating circulator is supplied with mains power via a link cable from the refrigerated bath; on 120V equipment, the heating circulator has its own permanently attached power cable with a NEMA 5-15P plug suitable for North American outlets.

### **230 V equipment**

Connect the heating circulator using the mains link cable by plugging it into the “Mains power inlet” on the heating circulator (see section 4.2.1 figure 2) and the “mains outlet for heating circulator” on the refrigerated bath (see section 4.2.2 figure 4). Connect the equipment to the mains supply by plugging the mains supply lead into the “Mains power cable inlet” on the refrigerated bath (see section 4.2.2 figure 4) and a suitable mains power outlet in the building.

**CAUTION:** Take care not to plug the heating circulator into the “mains outlet for accessory pump” (see section 4.2.2 figures 4 & 5) as this will blow the replaceable accessory pump fuse. It won't cause any further damage, but it will cause inconvenience.

### **120V equipment**

Connect the heating circulator by plugging its fixed cord-set into a suitable mains power outlet in the building. Connect the refrigerated bath to the mains supply by plugging the mains supply lead into the “Mains power cable inlet” on the refrigerated bath (see figure 5) and a suitable mains power outlet in the building.

**CAUTION:** this equipment is designed to be connected to wall outlets with branch circuit protection. Use only the supplied mains cords or identical replacements. The heating circulator mains cord is not replaceable by the user (see section 9.4).

## **4.7 Recommended liquids**

The following table lists the recommended liquids for different temperature ranges. Always ensure the liquid used is safe and suitable for your working temperature.

It is the user organisation's responsibility to assess the risks associated with the choice of heat transfer liquid chosen and to put in place safe working practises and appropriate protective equipment for personnel where considered necessary.



To ensure protection the over-temperature cut-out must be set appropriately for the heat transfer liquid selected (see table below)



Use fume extraction when using silicone fluids at elevated temperatures

Temp range	Recommended liquid	Comments
-30°C to 30°C	Silicone oil – low viscosity	Bayer silicone M3. Follow the manufacturer's instructions. For safe disposal consult your local regulations.
-30°C to 70°C	50% water, 50% antifreeze (inhibited ethylene glycol)	 Ethylene glycol is toxic – follow the manufacturer's instructions. For safe disposal consult your local regulations. Use a lid to reduce the dilution of the mixture caused by condensing water vapour from the air, and to maintain the cool down rate.
0°C to 70°C	80% water, 20% antifreeze (inhibited ethylene glycol)	
5°C to 95°C	Water*	Water can be used but care should be taken above 60°C as hot vapour can be dangerous. The equipment should not be used to boil water.
70°C to 150°C	Silicone fluid Viscosity ~20cs Flash point ≥230°C Fire Point ≥280°C	Dow Corning DC200/20 silicone fluid is a suitable liquid – follow the manufacturer's instructions. For safe disposal consult your local regulations.

\* See section 7.1 for further details

## 5.0 Operating procedures

---

### 5.1 Preparing the ecocool 150R for use

#### 5.1.1 Liquid level

Remove the lid and fill the tank to an appropriate level with a liquid suitable for your working temperature; see section 4.7 for liquid options.

Maximum fill level	190 mm (10 mm from the top of tank)
Minimum fill level	160 mm (40 mm from the top of the tank)

If silicon oil is used, adjust the maximum and minimum fill levels to allow for thermal expansion and contraction of the liquid during operation to prevent overspill. Allow for any liquid in external circulation paths. If using liquids that can evaporate, then periodic checking and refilling should be completed. The fluid must cover the cooling coil to maintain the cooling power and prevent condensation. Refit the lid when filling is complete.

The low liquid level float switch will alarm if the liquid level drops below the level required to safely cover the heater. The alarm will switch off the heater, cooler and stop temperature control. This is a safety measure to prevent damage to the equipment, not an indication that the liquid level has dropped below the minimum recommended level given above.

#### 5.1.2 Tank lid

Always keeps the lid fitted when operating the equipment.



Take care when lifting and removing the lid as it may be hot. Steam and hot vapours can cause scalding.

#### 5.1.3 Setting the over-temperature thermostat

An over-temperature cut-out dial with a temperature scale is located at the top right of the heating circulator. The over-temperature probe independently monitors the bath temperature and switches the heater off if it goes above the cut-out threshold.

##### Coarse setting of the over-temperature thermostat

Rotate the temperature cut-out dial in line with the marked scale to the desired setting. This should be higher than the set temperature to avoid operating the cut-out before the set temperature has been reached. If the alarm is triggered the sounder can be silenced by pressing either the **F** or **S** button once. To continue to use the heating circulator, let the bath liquid cool by at least 5°C, either naturally or by replacing the liquid, switch the equipment off, wait 10 seconds and switch it on again to clear the alarm. To avoid nuisance tripping the trip point needs to be set at least 5°C above the desired control temperature.

##### Alternative setting of the over-temperature thermostat

Rotate the temperature cut-out dial to maximum (or at least a value above the level required) and configure the set temperature to the cut-out level required. Leave the bath to reach the set temperature and stabilise for at least 5 minutes. Turn the cut-out dial slowly anticlockwise until an over-temperature fault is displayed on screen and the alarm sounds continuously. This gives an over-temperature trip point at the set temperature. The audible alarm can be cancelled by pressing either the **F** or **S** button once.





To continue to use the heating circulator, let the bath liquid cool by at least 5°C, either naturally or by replacing the liquid, switch the equipment off, wait 10 seconds and switch it on again to clear the alarm. To avoid nuisance tripping the trip point needs to be set at least 5°C above the desired control temperature.

#### 5.1.4 Using the heating circulator pump

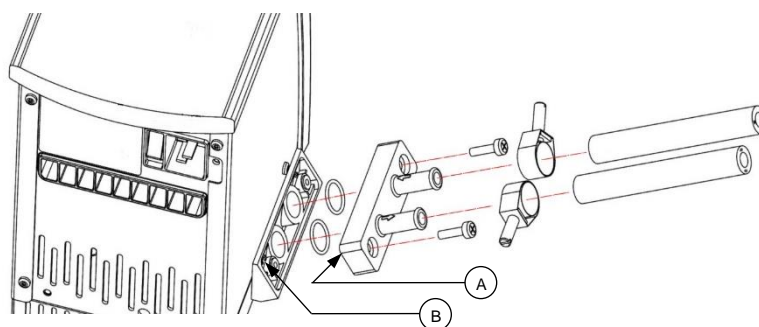
The heating circulator allows liquid to be pumped around a closed external system (not open to the atmosphere). It cannot be used for circulation through an external open tank. The pump is fitted with a blanking plate as standard. Fit a pump connector plate as shown below. Ensure o-rings are located in the grooves, use silicone grease to hold the o-rings in place. Note: the blanking/connector plates have a locating hole (see A below) to assist correct alignment onto the pump moulding. It is important to verify the hole is aligned with the corresponding locating pin (see B below) on the pump moulding. Failure to do so will result in a leaking connection. Retain the blanking plate for refitting when the pump is no longer required.

The equipment is supplied with insulated hose which is designed to operate at temperatures between -40°C to 100°C. Suitable high temperature hose HOSE 200 is recommended for temperatures above 100°C.



-  Always use pump connectors and hoses that are suitable for the operating temperature and liquid used. Check the pipe connections are secure.
-  Never disconnect any pipes or hoses while they contain very hot or very cold liquids or while the equipment is pumping.
-  Never use silicone oil with silicone tubing.
-  Switch off the equipment when connecting and disconnecting hoses

Pumping heat transfer liquid around an external system can lead to hazards that are outside the control of Grant Instruments. It is essential that the user organisation conducts a risk assessment of the entire equipment installation to ensure that correctly rated materials have been used throughout and that the system can be used safely.

### 5.1.5 Using the switch over relay output

An internal relay provides switch over contacts that can be used to control external equipment. The pin connections on the rear panel 3 pin circular connector are:

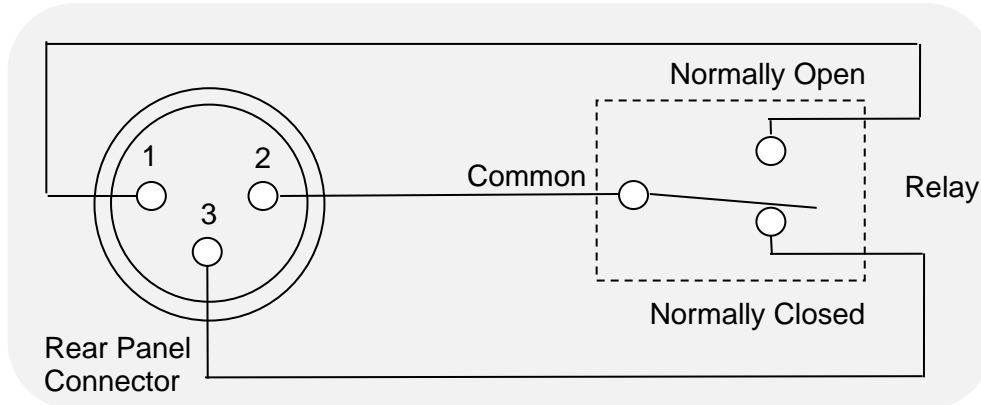

For the connecting cable use a mating XLR style connector such as the NC3FXX manufactured by Neutrik AG

The switch over contacts is rated at 24Vac or dc 2A maximum.



The relay is rated 24Vac or dc at 2A; to prevent injury or equipment damage, do not connect to greater voltages or attempt to switch greater currents.



Voltages as low as 22Vac can be hazardous in locations where wetting of the skin can occur. When making up cable to connect your equipment to the relay connector, on the heating circulator, make sure that the insulation system used is adequate to provide protection against the voltages output by your equipment for switching by the relay.



Always use the correct size cable with correct class of insulation for the voltage being switched. If in doubt contact the technical support team at Grant.

### 5.1.6 Emptying the liquid tank

The tank should be emptied to a safe level prior to moving. A drain tap is included to at the front of the equipment to allow convenient emptying. See section 4.2.2 figure 3 for full details.



Liquid to be drained should not be below 10°C or above 50°C.

### 5.1.7 Setting up and switching on

Follow instructions in section 5.1.4 to attach the pump connector plate and insulated hose. Before filling and switching on, attach the open end of the hose to the application, taking care to note the inlet and outlet.



Ensure all hoses are connected securely. Liquid will begin pumping immediately once equipment is switched on.

Add the appropriate working liquid to the bath to at least the minimum recommended fill level. See section 5.1.1

Refer to section 4.6 for the instructions for connecting the equipment to the mains supply.

For 230V equipment.

Make sure the heating circulator power switch is in the ON position.

For 120V equipment.

The refrigerated bath and heating circulator must be switched on separately. Note that the refrigerated bath will not operate until the heating circulator has started up.

When working at high temperatures, ensure the cables are not touching hot surfaces or air vents

Switch on the equipment using the power switch on the front of the refrigerated bath (and the switch on the heating circulator for 120V equipment). The heating circulator motor will start immediately and the buzzer will sound. The heating circulator will display the model and the software version number. The equipment will now display the current liquid temperature and start to heat or cool to reach the set point temperature.

### 5.1.8 Eco mode cooling

The equipment has variable power cooling as well as heating. This enables the equipment to achieve and maintain the required temperature using minimum energy without a loss in performance. The equipment is preset to run in this energy saving Eco mode. The eco mode icon on the heating circulator display indicates when the equipment is set to eco mode. The cooling can also be set to OFF or HIGH for continuous maximum available power. See section 5.3.2 to configure the cooling mode.



## 5.2 Using the equipment controls

### 5.2.1 Setting the control temperature



1. Rotate the dial on the heating circulator until the **set temperature** icon is highlighted, press the **S** button.

2. Rotate the dial to set the desired temperature.

*If no key is pressed for 10 seconds or if **F** is pressed, the set temperature icon is no longer active and will remain at its original value.*

3. Press **S** to store the requested value.

*If the temperature selected is higher than the current liquid temperature the heater will switch on and the heater icon will be displayed.*

### 5.2.2 Setting a pump speed



1. Rotate the dial until the **pump speed** icon is highlighted, press the **S** button.

2. Rotate the dial to set the desired pump speed over a range of 1 to 5 (1= lowest speed, 5 = highest speed).

*If no key is pressed for 10 seconds or if **F** is pressed, the pump speed icon is no longer active and will remain at its original value.*

3. Press **S** to store the pump speed.

*The pump will now operate at the stored pump speed.*

*For set temperatures above 150°C, the pump will automatically operate at a minimum of speed 3.*

### 5.2.3 Running a bath preset

The heating circulator contains three presets which can be configured to different set temperatures. This allows the equipment to be conveniently run at frequently used temperatures and pump speeds. See section 5.3.1 for information on preset configuration.



1. Rotate the dial until the **preset** icon is highlighted, press the **S** button.
2. Rotate the dial to select the desired preset 1, 2 or 3, press **S** to run the preset.

*The preset will automatically start as soon as S is pressed.*

*If no key is pressed for 10 seconds or if **F** is pressed the preset icon is no longer active and will remain at its original value.*

Preset temperatures and set temperatures are limited to the liquid selection. The control settable range is between -30°C and 150°C.

#### 5.2.4 Running a countdown timer

The countdown timer on the heating circulator can be set in the range of 1 minute to 99 hours. The countdown timer will sound a buzzer at the end of a countdown period.



1. Rotate the dial until the **countdown timer** icon is highlighted, press the **S** button.

*The countdown timer will display the last countdown time set.*

*If no key is pressed for 10 seconds or if **F** is pressed the countdown timer setting is no longer active and will remain at its original value.*

2. Rotate the dial to set the desired countdown time, press **S** to store.

*The countdown timer will begin counting down from the set time. At the end of the countdown timer period a buzzer will sound. This can be cancelled by pressing **F** or **S**.*

To cancel an active countdown timer:

1. Rotate the dial until the **countdown timer** icon is highlighted, press the **S** button.
2. Press the **F** button to cancel the countdown timer.

*The countdown timer is stopped.*

#### 5.2.5 Running a program

The heating circulator has the capability to run automatic temperature profiles called programs. It has the capacity to store 1 program containing 30 individual temperature/time segments. The program can only be configured and edited using Grant Labwise™ software. When a program is running icon access is limited to the standby and program functions.



1. Rotate the dial until the **program** icon is highlighted, press the **S** button.

*If no key is pressed for 10 seconds or if **F** is pressed, the program icon is no longer active and will remain at its original value.*

2. Rotate the dial until program “1” is displayed. By default the heating circulator will display program “–” indicating that no program is selected. Press **S** to select the program.

*The selected program will start. The display will show the target temperature of the first segment and the countdown timer will indicate the duration of the program remaining. Whilst a program is running only the Standby icon can be selected. At the end of a program the buzzer will sound, this can be cancelled by pressing **F** or **S**.*

To stop a program

1. Rotate the dial until the **program** icon is highlighted, press the **S** button.

*If no key is pressed for 10 seconds or if **F** is pressed, the program icon is no longer active and will remain at its original value and the program will continue to run.*

2. Rotate the dial until the “–” is displayed, press **S** to select

*The program will stop. The display will remain at the set temperature reached when the program was stopped, the countdown timer will stop at the remaining time and the pump speed will display the last speed set.*

### 5.2.6 Activating standby mode

In standby mode the heating circulator is still powered, however key functions (heating, pump, countdown timer and programs) are switched off. In standby mode access is limited to the settings menu, enabling the functions such as alarms and programs to be configured while the equipment is not operating.

*Note. When entering standby mode the pump will remain ON for 5 minutes to allow internal cooling to continue.*

*If a countdown timer has been set or a program is running before activating standby mode they will be terminated.*



1. Rotate the dial until the **standby** icon is highlighted, press the **S** button.

*The **temperature** and **countdown timer** values are no longer displayed.*



2. To resume operation, rotate the dial until the **standby** icon is highlighted, press the **S** button.

*The display returns to the home screen and the heating circulator resumes operation at the last temperature and pump speed set.*

### 5.2.7 Accessing the settings menu

The settings menu provides access to the following settings screens: preset selection and definition, program selection and definition, liquid type, probe (internal or external), alarms, buzzer level and language. Section 5.3 provides detailed information on viewing, editing and saving settings.



1. Rotate the dial until the **settings** icon is highlighted, press the **S** button.

*The settings menu is displayed, with presets highlighted at the top of the list.*

Shortcut to settings menu. Pressing **F** whilst in the home screen when the cursor is white will automatically display the settings menu

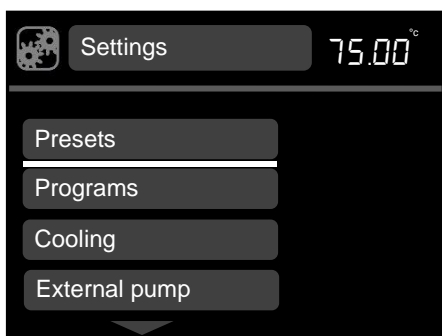

2. Rotate the dial to scroll up and down the list, until the desired setting is highlighted, press the **S** button to select. The desired settings menu is displayed.

*Pressing **F** returns to the home screen without making changes.*

## 5.3 Viewing, editing and saving settings

### 5.3.1 Configuring a preset



1. Rotate the dial until the **settings** icon is highlighted, press the **S** button.

*Pressing **F** returns to the home screen without making changes.*

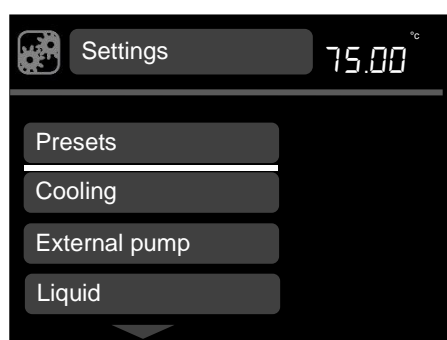

2. Rotate the dial to scroll up and down the list, until **preset** is highlighted, press the **S** to select.

*Pressing **F** returns to the settings screen without making changes.*

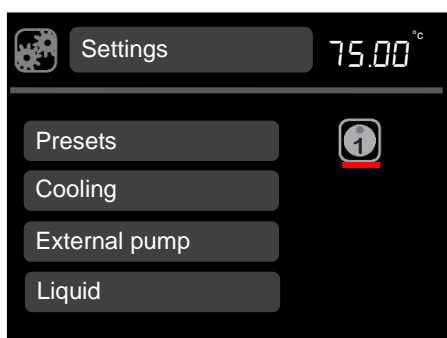

3. Rotate the dial to display preset icon 1, 2 or 3, press **S** to select.

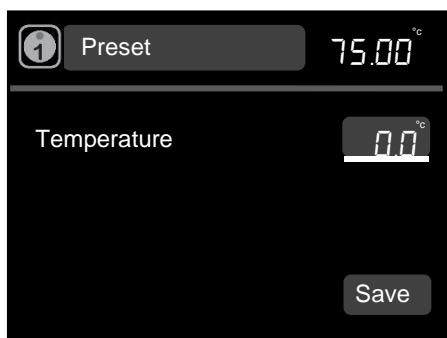

4. **Temperature** is highlighted, press the **S** button. Rotate the dial to define the temperature. Press **S** to set.

*Pressing **F** restores the original preset temperature with temperature highlighted.*

*Pressing **F** restores the original preset pump speed with pump speed highlighted.*

To save the temperature and pump speed configuration, rotate the dial to highlight **save** and press **S**  
*The display returns to the settings menu screen.*

*Repeat procedure to configure presets 2 and 3*

5. Press **F** to return to the home screen.

### 5.3.2 Setting the cooling mode



1. Rotate the dial until the **settings** icon is highlighted, press the **S** button.

*Pressing F returns to the home screen without making changes.*

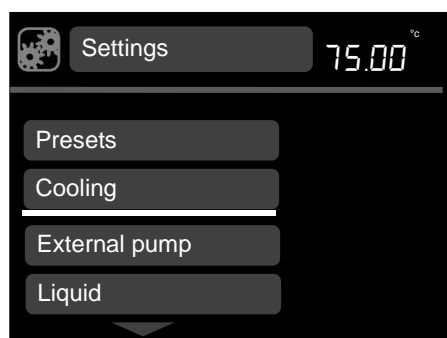

2. Rotate the dial to scroll up and down the list, until **cooling** is highlighted, press the **S** to select.

*The Cooling options are displayed.*

*Pressing F returns to the settings screen without making changes.*

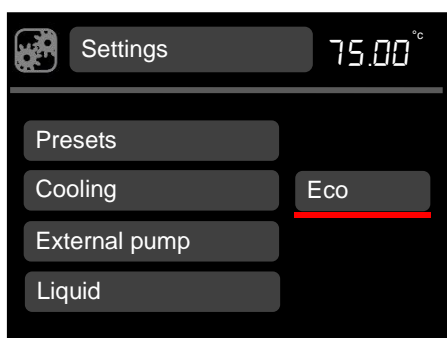

3. Rotate the dial to display the options: Off, Eco or High.

Off = No cooling

Eco = Minimum energy mode

High = Continuous maximum available cooling power

4. Press the **S** to select and save the option

*The display returns to the settings screen.*

4. Press **F** to return to the home screen.

*Note that on high power setting the cooling power will still be controlled when operating at high fluid temperatures to protect the refrigerated bath*

### 5.3.3 Switching on the external pump



1. Rotate the dial until the **settings** icon is highlighted, press the **S** button.

*Pressing F returns to the home screen without making changes.*

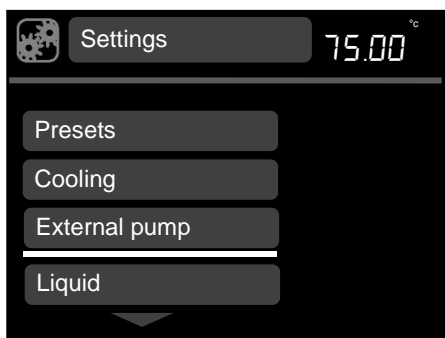

2. Rotate the dial to scroll up and down the list, until **External pump** is highlighted, press the **S** to select.

*The Pump options are displayed.*

*Pressing **F** returns to the settings screen without making changes.*

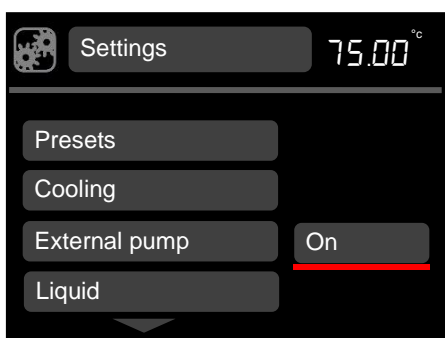

3. Rotate the dial to display the options: On, Off
4. Press the **S** to select and save the option

*The display returns to the settings screen.*

5. Press **F** to return to the home screen.

*Note that if a pump is already connected, it will start pumping immediately. The heating circulator will remember the pump setting when switched off.*

### 5.3.4 Selecting a liquid type

The liquid type determines the limits of the set point temperature range.

Selection of the liquid types below changes the settable temperature range as follows:

Liquid	Set temperature range
Water	5°C to 100°C
Water-Glycol	*-25°C to 70°C
Low Temp Oil	-25°C to 30°C
High Temp Oil	†70°C to 150°C
Override	§-25°C to 150°C

\* Water-Glycol (50% water, 50% antifreeze (inhibited ethylene glycol))

† High Temp Oil (silicone fluid with the following characteristics: viscosity 20 centistokes, flash point  $\geq 230^{\circ}\text{C}$ , fire point  $\geq 280^{\circ}\text{C}$ ).

See section 4.7 for full description of recommended bath liquids.

§ When set to Override it is the user's responsibility to select a suitable safe liquid.

See section 4.7 for full description of recommended bath liquids and precautions when selecting a liquid.

Always ensure the liquid used is safe and suitable for your working temperature. It is the user's responsibility to assess the risks associated with the choice of heat transfer liquid chosen and to put in place safe working practises and appropriate protective equipment for personnel where considered necessary.



To ensure protection the over-temperature cut-out must be set appropriately for the heat transfer liquid selected.



When changing the liquid from water to oil for operating above 100°C, ensure all residue of water is removed from the pump and hoses. There is a risk of scalding from boiling water



1. Rotate the dial until the **settings** icon is highlighted, press the **S** button.

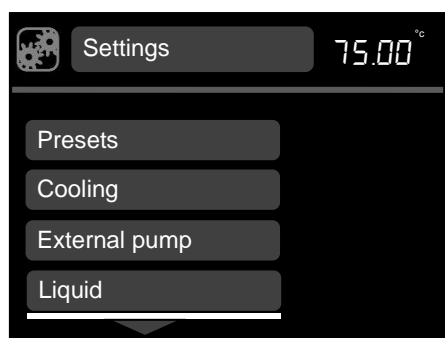

2. Rotate the dial to scroll up and down the list until **liquid** is highlighted, press **S** to select.

*Liquid options are displayed.*

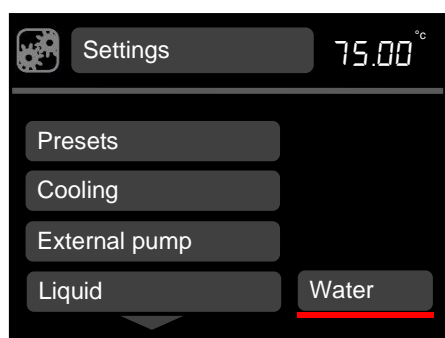

3. Rotate the dial to scroll through the liquid options, press **S** to save the selection.

*The display returns to the settings screen.*

5. Press **F** to return to the home screen.
6. Change the Over Temperature Cut-Out to be approximately 5°C above the new working set point temperature. See Section 5.1.3



### 5.3.5 Selecting a temperature probe type

The bath temperature can be controlled using an internal or external temperature probe.



1. Rotate the dial until the **settings** icon is highlighted, press the **S** button.

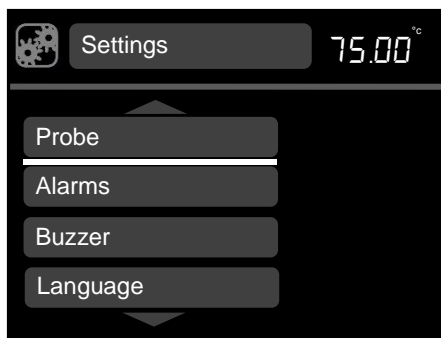

2. Rotate the dial to scroll up and down the list until **probe** is highlighted, press **S** to select.

*Probe options are displayed*

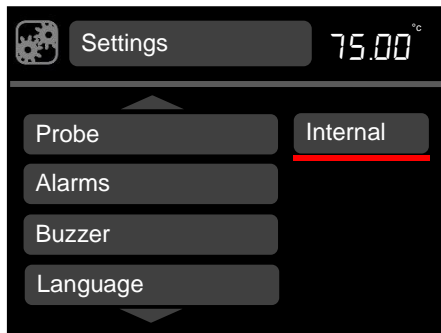

3. Rotate the dial to scroll through the probe types (**external** or **internal**), press **S** to save the selection

*The display returns to the settings screen.*

*The external probe icon will be displayed on the home screen*

4. Press **F** to return to the home screen.

### 5.3.6 Configuring high and low temperature alarms

There are three functions in the alarm menu.

1. A high alarm function, which causes an alarm condition when the bath temperature goes higher than the alarm value. The alarm value can be set as a fixed temperature above the set temperature or a deviation offset value above the set temperature. Below is an example of a high temperature deviation alarm, where the deviation value has been set to 5°C.

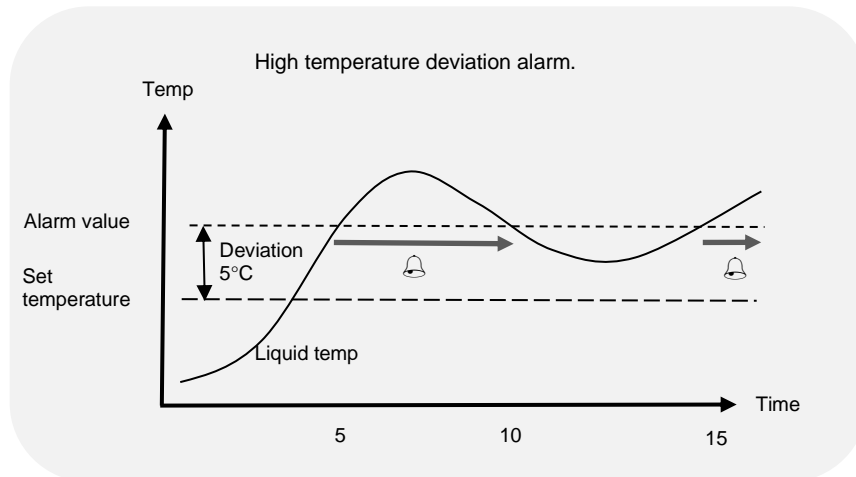

2. A low alarm function, when the bath temperature goes lower than the alarm value. The alarm value can be set as a fixed temperature below the set temperature or a deviation offset value below the set temperature. Below is an example of a low temperature fixed alarm, where the fixed temperature value has been set to -20°C.

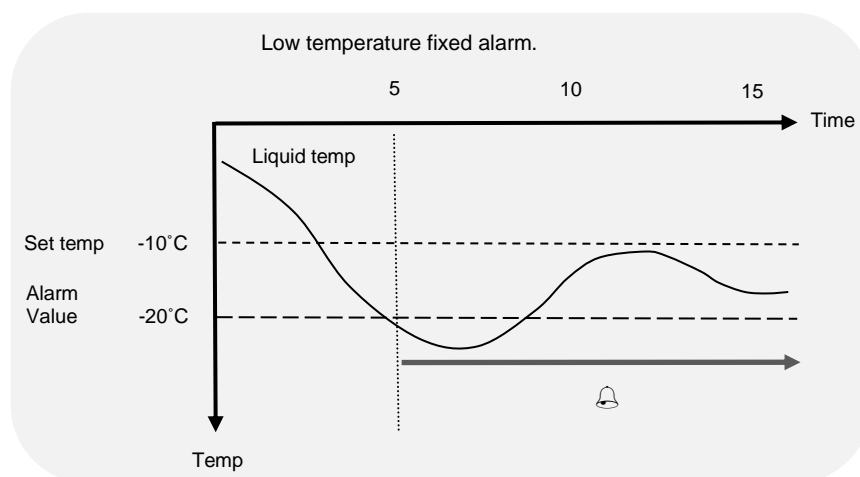

3. A hold-off time can be entered, which is a user adjustable time of between 0 and 21mins for which the alarms remain muted after either button has been pressed to acknowledge an alarm condition. If the bath returns to the value such that the alarm level is not exceeded the alarm will cancel. However, if the temperature remains outside the alarm level the alarm condition will re-occur after this hold-off time.

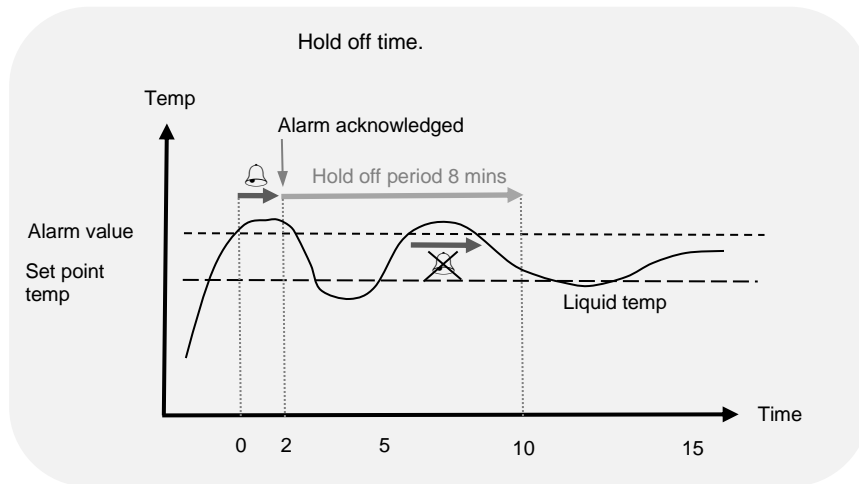

Each alarm can be programmed to latch, activate an audible buzzer and a relay. Alarms are cancelled by pressing the **F** or **S** button or if an alarm condition has been removed.



1. Rotate the dial until the **settings** icon is highlighted, press the **S** button.

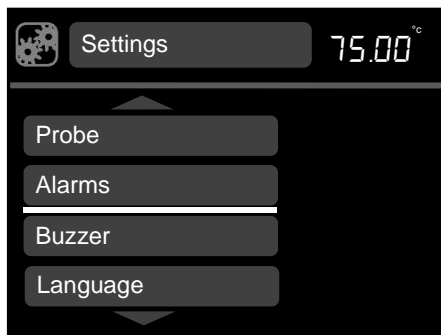

2. Rotate the dial to scroll up and down the list until **alarms** are highlighted, press **S** to select.

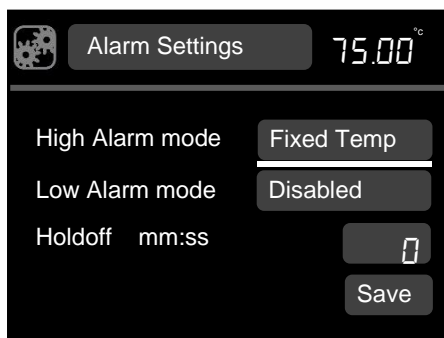

3. **High alarm mode** is highlighted, press **S** to select.
4. Rotate the dial to select **fixed temp, deviation** or **disabled**. Press **S** to select.

*The high alarm screen is displayed*

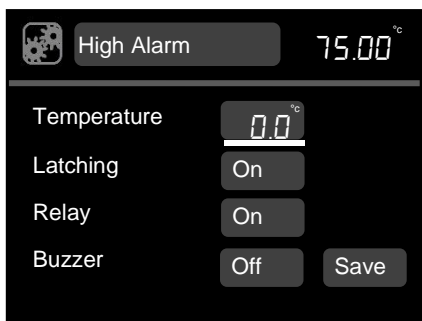

5. **Temperature** is highlighted, press **S** to select.
6. Rotate the dial to define the temperature value, press **S** to set.

7. Rotate the dial to highlight **latching**, press **S** to select.

8. Rotating the dial will display **on/off**, press **S** to select.

*When latching is on, a temperature alarm continues unless acknowledged by the user even if the temperature comes back in range*

9. Rotate the dial to highlight **relay**, press **S** to select.

10. Rotating the dial will display **on/off**, press **S** to select.

11. Rotate the dial to select **buzzer**, press **S** to select.

12. Rotating the dial will display **on/off**, press **S** to select.

13. Rotate the dial to **save**, press **S**. The display returns to the alarm settings screen. The procedure can be repeated to configure a deviation alarm and for the low alarm function.

14. Rotate the dial to highlight **hold off**, press **S** to select.

15. Rotate the dial to select a hold off time (over a range of 5 to 600 seconds), press **S** to select.

Rotate the dial to **save**, press **S** to save all settings.

*The display will return to the settings menu*

16. Press **F** to return to the home screen

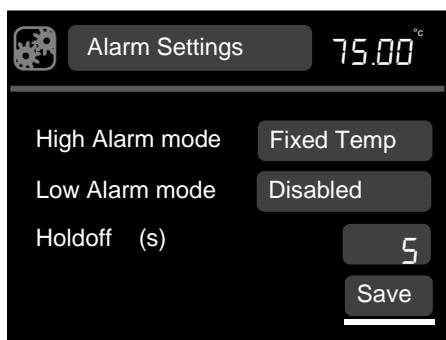

### 5.3.7 Setting the buzzer volume level

Three buzzer volume levels are available, low, medium and high and off.



1. Rotate the dial until the **settings** icon is highlighted, press the **S** button.

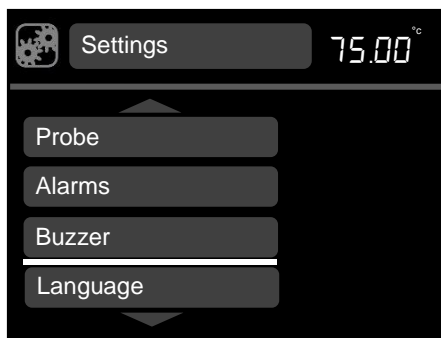

2. Rotate the dial to scroll up and down the list until **buzzer** is highlighted, press **S** to select.

*Volume options are displayed.*

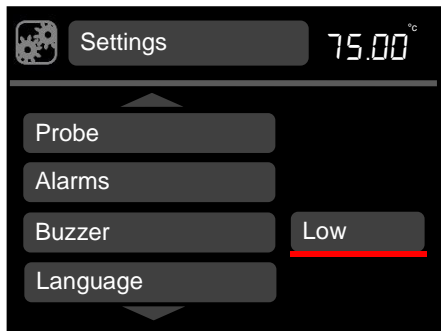

3. Rotate the dial to scroll through the volume levels (low, medium and high and off), press **S** to save the selection.

*The display returns to the settings screen.*

4. Press **F** to return to the home screen.

### 5.3.8 Selecting a language

Five language options are available, English, French, German, Italian and Spanish.



1. Rotate the dial until the **settings** icon is highlighted, press the **S** button.

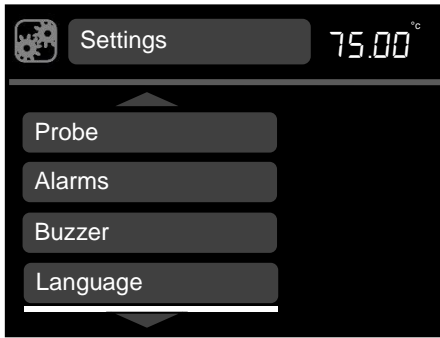

2. Rotate the dial to scroll up and down the list until **language** is highlighted, press **S** to select.

*Language options are displayed.*

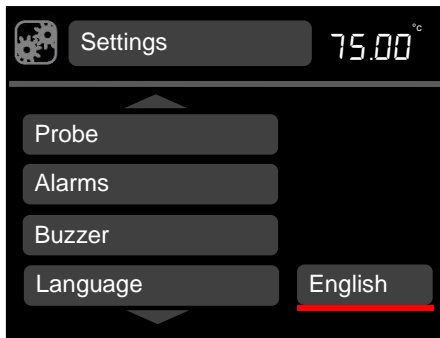

3. Rotate the dial to scroll through the language options (**English, French, German, Italian** and **Spanish**) press **S** to save the selection.

*The display returns to the settings screen.*

4. Press **F** to return to the home screen.

### 5.3.9 Relay test and configuration

The heating circulator can be configured to switch a relay in the program function. This function can be tested manually outside the program function by following the instructions below.



1. Rotate the dial until the **settings** icon is highlighted, press the **S** button.

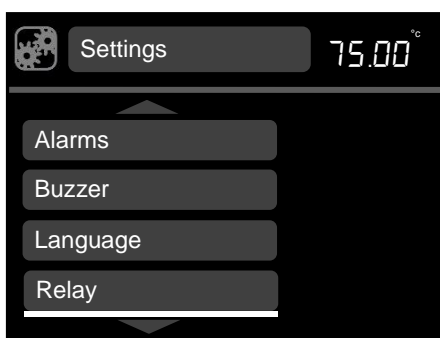

2. Rotate the dial to scroll up and down the list until **relay** is highlighted, press **S** to select.

*Relay options are displayed*

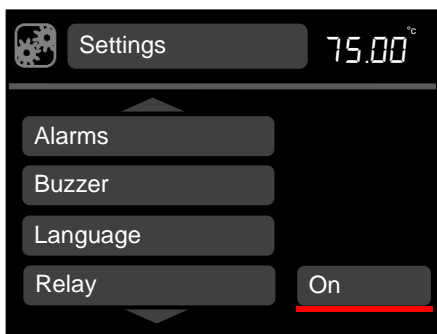

3. Rotate the dial to toggle between on/off, press **S** to save the selection.

*The display returns to the settings screen.*

4. Press **F** to return to the home screen.

### 5.3.10 Display rounding

The heating circulator can be configured to show a rounded temperature display rather than showing the minor changes that occur as the heater pulses to maintain the temperature.



1. Rotate the dial until the **settings** icon is highlighted, press the **S** button.

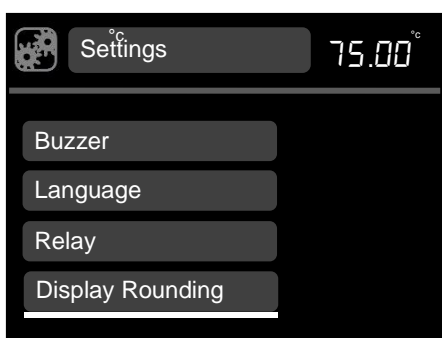

2. Rotate the dial to scroll up and down the list until **display rounding** is highlighted, press **S** to select.

*Display rounding options are displayed.*

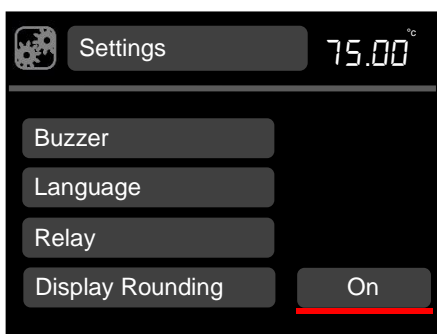

3. Rotate the dial to toggle between on and off, press **S** to save the selection.

*The display returns to the settings screen.*

4. Press **F** to return to the home screen.

## 5.4 Completing a calibration

The heating circulator allows up to five temperature points to be calibrated. The calibration menu can be accessed by simultaneously pressing the **F** and **S** buttons for 3 seconds

The calibration temperatures are constrained by the temperature limits of the liquid type setting. Calibration should be carried out using a traceable reference thermometer with an accuracy of at least 0.1°C. This thermometer should be held securely in the centre of the bath or vessel.

Two factory defined calibration points (20°C and 70°C) already exist and are displayed in the calibrate probe menu, these may be recalibrated if required and up to a further three calibration points added. Calibration points should be chosen to be at critical experimental temperatures where accuracy is important or at the extremes of the working range of used temperatures.

The heating circulator calculates the temperature at any point using calculated values that pass through each calibration point. This ensures precision at all critical experimental temperatures throughout the range in use. In the example below, 4 calibration points have been used.

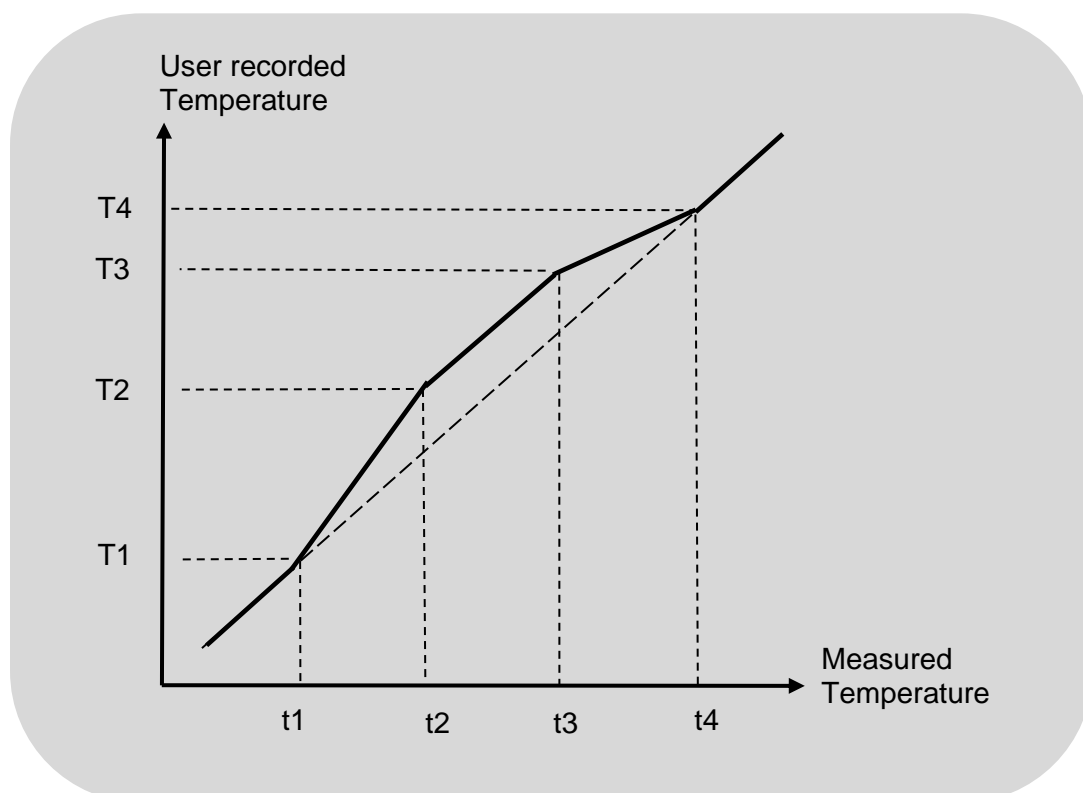

Calibration points must be a minimum of 5°C apart and there must be at least 20°C between the highest and lowest points. Any points added that do not match these criteria will not be accepted by the equipment.

Once set, calibration points can be changed or deleted but a minimum of 2 points must remain.

Prior to calibration, ensure the probe type to be calibrated is selected, (internal or external); the bath is set to the desired temperature and has been stable at the temperature for at least 5 minutes.



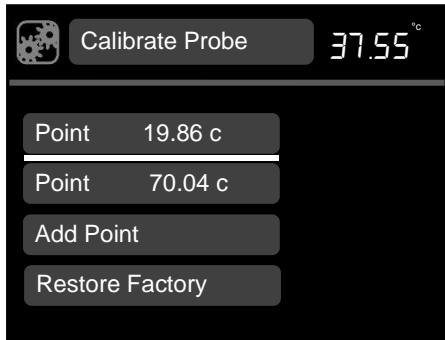

1. Press the **F** and **S** buttons simultaneously for 3 seconds.

*The calibrate probe menu displays the factory defined calibration points and the current temperature of the bath in the top right corner of the screen.*

2. Rotate the dial to highlight **add point**, press **S** to select.

*The calibrate point menu is displayed. If an external probe has been selected the external probe icon will be displayed in the top left corner. Otherwise the settings icon will be displayed when calibrating the internal probe.*

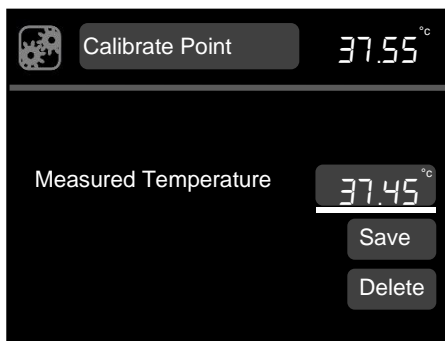

3. Rotate the dial to highlight **measured temperature**. Press **S** to select
4. Rotate the dial until the temperature being shown on the calibrated thermometer is displayed on screen. Press **S** to save the value.
5. Rotate the dial to highlight **save**, press **S** to select.

*The display returns to the calibrate probe screen.*

6. Press **F** to return to the home screen

*Further calibration points can be added by repeating steps 2 to 5. Calibration points can be deleted by selecting **delete** in the calibrate point screen.*

### 5.4.1 Restoring factory calibration settings

If the thermometer value is entered before the bath temperature is completely stable the calibration could be poor and liquid temperature readings will be incorrect. If the heating circulator is not in accordance with the thermometer following calibration then it may not have been successful and the equipment should be reset, using the restore factory settings function.

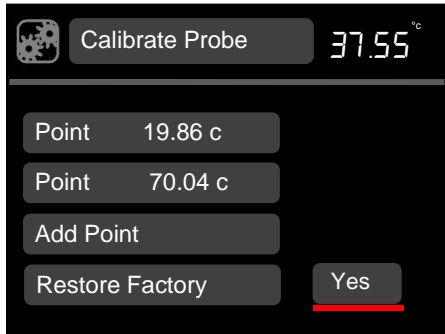

1. Press the **F** and **S** buttons simultaneously for 3 seconds.
2. Rotate the dial to highlight **restore factory**, press **S** to select.

*Yes/No are displayed.*

3. Rotate the dial to toggle to **yes**, press **S** to select. *Factory calibration values are restored.*
4. Press **F** to return to the home screen

## 6.0 Technical specifications

---

### 6.1 Operating conditions

Ambient temperature range	5 to 30°C
Altitude above sea level	Up to 2,000m (6,500ft)
Operating environment	Indoor use only
Maximum relative humidity	80% RH up to 31°C

### 6.2 Electrical details

Mains supply: 220-240V @ 50/60Hz or 110-120V @ 50/60Hz

Pollution degree: 2

Installation category: II

Mains supply voltage fluctuations are not to exceed  $\pm 10\%$  of the nominal supply voltage.

### 6.3 Performance

Specification		ecocool 150R	ecocool 150 US
Typical cooling power at an ambient of 20°C	@ 20°C	450W	
	@ 0°C	350W	
	@ -10°C	300W	
	@ -20°C	200W	
	@ -30°C	50W	
Stability (DIN 12876) @ -10°C		$\pm 0.02^\circ\text{C}$	
Settable temperature range		-30°C to 150°C	
Tank capacity		5.5L	
Top opening		120 x 155mm	
Liquid depth min/max		130/145mm	
Tank depth		155mm (usable 145 leaving 10mm clear)	
Weight		24kg	
Max pump head pressure		530mBar	
Max pump flow rate		14-22 Litre/min adjustable	
Safety temperature limit		User settable cut-out above 20°C	
Max current consumption		12A	19A *
Heater power		1.9kW	1.4kW

\*Requires two separate mains cords

### 6.4 Storage and transportation

Store and transport in original packaging. Temperature range -20°C to +60°C

## 7.0 Technical Tips

---

### 7.1 Which water should you use in your equipment tank?

For the long-term reliability of the equipment, it is important to use oxygenated water that is free from ions and minerals that can cause corrosion of stainless steel. We recommend the use of distilled water and de-ionised water from modern ion exchange systems that do not use salt back flushing to regenerate the ion-exchange cartridges.

Stainless steel is protected from corrosion by a layer of chromium oxide. If the layer is damaged, oxygen present in water can reform the oxide layer. If the water is still or de-oxygenated, and the oxide layer is damaged, ions can corrode the stainless steel tank. If a water bath has been unused for some time, or water boiled, we recommend changing to fresh distilled water or correct de-ionised water.

Water normally contains calcium or magnesium ions. De-ionised water has most ions removed as indicated by its conductivity level; the purer the water the lower the conductivity. It is important to use only de-ionised water from an ion exchange system with replaceable cartridges. Do not use de-ionised water generated from an ion-exchange system that incorporates a salt back-flush system to regenerate the ion-exchange resin as this can leave sodium ions that are very corrosive to stainless steel.

### 7.2 How to prevent rust in the equipment tanks

Most Grant tanks, as well as immersed parts, are made from type 304 stainless steel, an extremely versatile general purpose grade of stainless steel. It is the excellent forming characteristic that has made this grade dominant in the manufacture of laboratory and industrial water baths, as well as domestic sinks and saucepans. Type 304 stainless steel is highly suitable for applications where hygiene is important; it exhibits good heat resistance and excellent resistance to corrosion.

However, despite resistance to general surface corrosion, stainless steel is susceptible to specific types of corrosion, in particular pitting (small pin hole style corrosion) and stress corrosion cracking. It can also undergo general corrosion in specific environments, such as one containing hydrochloric or sulphuric acids.

Stainless steel is protected by its high content of alloying elements, primarily chromium and nickel. Chromium is the most important with respect to corrosion resistance, although the nickel assists in allowing the chromium to do its job. The chromium forms an oxide layer on the surface of the steel, which inhibits further oxidation. This layer adheres extremely well to the metal substrate, but it is essential that it remains intact, and must be protected from various forms of damage.

If the surface chromium oxide layer becomes damaged, oxygen present in water can partially reform the oxide layer, so it is advisable to ensure that water is always fresh and well oxygenated. Baths that will be out of use for an extended period should be emptied, and all moisture should be wiped from the bottom of the tank.

In some cases, a brown layer may appear on the surface of a stainless steel tank. In most of these cases this is not rust, but it may be a surface deposit of minerals from the local water supply, or ferrous particles or salts that have fallen into the tank. These surface deposits can usually be removed by using a household cleaner.

### **7.3 How to prevent algae and bacteria?**

Water baths provide the ideal environment for the growth of micro-organisms. If left uncontrolled, the growth of these organisms can result in a range of serious problems and health risks from pathogenic bacteria.

The growth of algae on the surface of parts will cause bio fouling which can reduce performance.

Micro-organisms that produce acidic metabolic by-products can cause bio-corrosion by depolarisation of metal surfaces.

There are a number of biocides available on the market.

## **8.0 Warranty information**

---

When used in laboratory conditions according to this manual, this product is guaranteed for THREE YEARS against faulty materials or workmanship.

Extended warranty for years four and five can be purchased by contacting our sales department [salesdesk@grantinstruments.com](mailto:salesdesk@grantinstruments.com).

## 9.0 Maintenance and service

---

### 9.1 Routine maintenance



**The refrigerated bath contains a flammable refrigerant:**

- Do not use mechanical devices or other means to accelerate defrosting: either turn the equipment off or set it to ambient temperature and wait until all the ice has melted.
- Do not damage the refrigerant circuit.

The over-temperature cut-out on the heating circulator should be checked periodically by turning the over-temperature dial with a screwdriver anticlockwise until the alarm is triggered. The equipment will sound a buzzer and “Over temperature Alarm” will be shown on the display. The over-temperature dial should then be turned to 10°C above liquid temperature and the heating circulator powered off and back on to confirm that the cut-out can be reset correctly. If the alarm is triggered when the value indicated on the over-temperature dial is more than 10°C below the current temperature as indicated by the main display, then the equipment should be checked by a competent person.

The float liquid level protection should also be checked periodically by lowering the level of liquid in the bath and noting that the equipment cuts out with the top turn of the heater still immersed in the liquid.

When hoses are fitted to the pump they should be inspected periodically and replaced as necessary to avoid hose failure.

No other routine maintenance is required.

### 9.2 Cleaning

Regular maintenance of the equipment unit is important to allow the equipment to perform to its specification and is required for warranty validity.

The removable grille of the refrigerated bath enables easy access to the condenser for cleaning. Cooling power will be reduced if the fins become clogged with dust. The condenser fins (see section 4.2.2 figure 3) should be examined monthly and, if necessary, use a vacuum cleaner nozzle and soft brush to remove the dust. Take care not to damage the condenser fins during cleaning. Always replace the condenser grille following cleaning



Allow the equipment to cool before cleaning the condenser fins



Unplug the equipments from the mains before commencing cleaning

Clean the outside of the equipment with a damp cloth, using water only. Do not use chemical cleaning agents. Before using any other cleaning or decontamination method, check with Grant Instruments or your local representative to make sure that the proposed method will not damage the equipment.

To aid cleaning the heating circulator can be removed from the refrigerated bath. Unfasten the thumbscrew at the rear of the refrigerated bath (see 4.4.2, Figure 4) and lift the heating circulator and top plate.

Scale on immersed parts can be removed using chemical de-scaling products designed for use on equipment that has metal parts. De-scaling products may be toxic and manufacturer’s instructions should always be followed

### 9.3 Fuses

The heating circulator and refrigerated fuses are internal and should not need to be replaced. Please contact the Grant Instruments service department if the equipment has a fuse fault.

The external pump power outlet has a user replaceable fuse. Replacement fuses must be 20mm x 5mm Quick blow type with 250V F2.5 A L rating.

Fuse replacement should only be carried out by a competent person.

### 9.4 Replacing the mains cord

This equipment must only be used with an appropriately approved cord set acceptable for the country in which the equipment is intended to be used.

The mains cord set must be suitably rated for the equipment it is intended to be used with, refer to the equipment rating label for further details.

No user replaceable parts, if the cord set is damage do not operate the equipment, disconnect from the supply immediately and contact Grant Instruments for replacement or your authorised service agent.

#### Guidance information table

Country	Cord type	Mains Plug	Appliance coupler
US	SJTW 14AWG 105°C	NS-3P	Not applicable
Canada			Not applicable
UK	H05VV-F 3G1.5mm <sup>2</sup> , 300/500V 90°C	BS 1363	IEC 60320, Type C20
Europe		IEC 60309	IEC 60320, Type C20

### 9.5 Routine safety tests

If routine tests are to be made, we recommend a test of the integrity of the protective earth conductor and an insulation test at 500V DC. Routine flash tests are not recommended for any electrical equipment, because repeated high voltage tests degrade insulation materials.

### 9.6 Disposal



The refrigerated bath contains flammable refrigerant gas which must NOT be discharged into the atmosphere. At the end of the equipment's working life, either have the gas removed safely by using refrigerant recovery equipment or return the equipment to Grant Instruments for disposal.

## 9.7 Service

If service is required, switch off the equipment and contact Grant Instruments or your local representative for repairs.

Please note all returned units must be accompanied by a Return Materials Authorisation (RMA) number, obtainable by contacting the Grant service department (details below).

Service Department  
Grant Instruments (Cambridge) Ltd  
Shepreth  
Cambridgeshire  
SG8 6GB  
UK

Tel: +44 (0) 1763 260 811  
E-mail: [service@grantinstruments.com](mailto:service@grantinstruments.com)









## 10.0 Optional accessories

### 10.1 Alternative pump

An internal pump comes as standard on the heating circulator. If greater head (pressure) is required you can choose from two accessory pumps and the appropriate pump lid. See the Grant website at [www.grantinstruments.com](http://www.grantinstruments.com) for full technical specifications.

Pump Product	Description
VTP1- LT	Max head pressure: 1000mBar Max flow rate: 9 L/min. Complete with lid for fitting to LT ecocool 150
VTP1L-LT	Max head pressure: 1000mBar Max flow rate: 9 L/min 120V
VTP2- LT	Max head pressure: 1700mBar Max flow rate 12 L/min. Complete with lid for fitting to LT ecocool 150

### 10.2 Pump connectors and other accessories



Connectors	Description	
P-M6	Replacement plastic pump inlet/outlet connector, fits 9mm ID, T° range -50 to 200°C	
P-M11	Replacement plastic pump inlet/outlet connector, fits 15mm ID, T° range -50 to 200°C	
M-M16	Stainless steel pump inlet/outlet connector, M16 x 1 male, T° range -50 to 200°C	
M-SR4	Metal pump inlet/outlet connector, dual seal super rapid 4mm, fits semi rigid tubing 4mm OD, T° range -20 to 100°C	
M-SR6	Metal pump inlet/outlet connector, dual seal super rapid 6mm, fits semi rigid tubing 6mm OD, T° range -20 to 100°C	
M-SR8	Metal pump inlet/outlet connector, dual seal super rapid 8mm, fits semi rigid tubing 8mm OD, T° range -20 to 100°C	
M-HB7	Metal pump inlet/outlet connector, hose barb 7mm, fits flexible tubing 7mm ID, T° range -40 to 120°C	
M-HB9	Metal pump inlet/outlet connector, hose barb 9mm, fits flexible tubing 9mm ID, T° range -40 to 120°C	
M-HB12	Metal pump inlet/outlet connector, hose barb 12mm, fits flexible tubing 12mm ID, T° range -40 to 120°C	
M-UC	Metal pump inlet/outlet plate, ¼" BSP/G1/4 female, T° range -50 to 200°C	
HOSE200	High temperature hose kit 2 x 2m for -50° to 200°C assembled with LT ecocool/Optima pump outlet plate and hose clips	

IQOQ LT ecocool 150	IQOQ documentation for the LT ecocool150	
PQ LT ecocool 150	PQ documentation for the LT ecocool150	

A full listing of product accessories and options is available in the Grant Scientific Reference Catalogue (a copy of which is available upon request) and on the Grant website at [www.grantinstruments.com](http://www.grantinstruments.com).

## 11.0 Troubleshooting

Symptom	Possible cause	Action required
Display shows "Check refrigerated unit" 	Refrigerated bath not connected  Refrigerated bath has overheated	Check the communications lead is connected to both the heating circulator and the refrigerated bath.  Wait for compressor to cool, when thermostat will reset and compressor will switch on again.  Remove any vent obstructions and carry out routine cleaning (see section 9.2)  If the problem persists, contact Grant Instruments.
Cooling performance reduced	Condenser fins clogged with dust	Carry out routine cleaning (see section 9.2)
Temp continues to rise when not expected	Set temp is higher than liquid temp	Check that the bath set temperature is correct (see section 5.2.1).
Set temperature too restricted	Liquid type set does not allow required set point	Change to different liquid type (see section 5.3.1).
Temperature does not rise when expected	Set temp is lower than liquid temp	Check that the bath set temperature is correct (see section 5.2.1).
Display shows "High Temperature Alarm"	High temperature warning alarm has tripped	Check that the bath set temperature is correct (see section 5.2.1).  Check that high temperature alarm is correct (section 5.3.6).  Check that the liquid level in the bath is adequate (see section 5.1.1 for minimum fill levels).
Display shows "Low Temperature Alarm"	Low temperature warning alarm has tripped	Check that the bath set temperature is correct (see section 5.2.1).  Check that low temperature alarm is correct (section 5.3.6).  Check that the liquid level in the bath is adequate
Unit showing erratic temperatures	Calibration values not set correctly	Restore the factory calibration settings (see section 5.4.1) then re-calibrate if required (see section 5.4).

Symptom	Possible cause	Action required
New calibration point is not saved	Incorrect calibration value	The temperature calibration point is less than 20°C from an existing calibration point – choose a higher temperature (see section 5.4).  The measured liquid temperature is more than 5°C away from selected calibration temperature.
Only the Standby icon can be highlighted	Unit is in standby mode	Highlight and Select the Standby icon and Press “S” to exit Standby mode.
Icons can be highlighted but not selected	Program running	Wait until program has finished or stop program
Select a program number but icon changes to “-“	Program not setup	Set-up and download a program using Grant Labwise software
Stirrer motor not rotating	Unit is in Standby Mode  Stirring propeller or pump impeller is obstructed  Faulty motor	Highlight the Standby Icon on the control screen and press S button to return to normal operation  Clear obstruction.  Have a competent person check the motor or contact Grant.
Display shows “Over temperature Alarm”. 	Over-temperature cut-out has operated	Check the set temperature is correct and that the over-temperature cut-out temperature is set at least 5°C above the set temperature (see section 5.1.3 for setting instructions).  If the over-temperature cut-out temperature is correctly set but the equipment still shows a “Over temperature Alarm” then the equipment has an internal fault and must be repaired before it is used again.
Display shows “Low liquid Alarm”. 	Liquid level has dropped below minimum level	Check that the liquid level in the bath is adequate
Display shows “Internal temperature probe Fault”. 	Faulty temperature probe	Have a competent person check the probe for an open or short circuit fault or contact Grant Instruments.

Symptom	Possible cause	Action required
Display shows "Internal/External Temp Diff Too Big"	There is a temperature difference of more than 5 degrees between the internal and external probe	Check the external probe is properly connected at the rear panel.  Check the external probe is correctly positioned in the bath liquid and circulation is not restricted.  If the external probe is not required, select the internal probe using the Settings menu
Display shows "Overheating- Power reduced "	Heating water at or near to boiling without lid  Heating very large volumes of liquid with large thermal losses	Add a lid to reduce thermal losses and leave unit running with the "Overheating" warning present. If the alarm has not cleared within 1 hour contact Grant Instruments.  Add measures to reduce thermal losses and leave unit running with the "Overheating" warning present. If the alarm has not cleared within 1 hour contact Grant Instruments.
Display shows "Service required 01"	Faulty fuse(s), relay or heater element	Have a competent person check the product or contact Grant Instruments.
Display shows "Service required 02"	Pump or propeller is obstructed Faulty motor	Remove obstruction. Have a competent person check the product or contact Grant Instruments.
Display shows "Cross-check Failure"	Internal Circuit Board fault	Have a competent person check the product or contact Grant Instruments.

For any other errors or service requests, please contact Grant Instruments [service@grantinstruments.com](mailto:service@grantinstruments.com)

## 12.0 Contact Grant Instruments

---

At Grant we are continuously trying to improve the performance we offer our customers. If you have any feedback on Grant's products or services we would like to hear from you. Please send all feedback to:

Quality Manager  
Grant Instruments (Cambridge) Ltd  
Shepreth  
Cambridgeshire  
SG8 6GB  
UK

Tel: +44 (0) 1763 260 811  
E-mail: support@grantinstruments.com

## 13.0 Compliance

---

### Waste Electrical and Electronic Equipment (WEEE)



This product marked with the crossed-out wheellie bin symbol indicating it must not be disposed of with unsorted waste. Safe recycling of WEEE helps conserve natural resources and protect human health.

Grant Instruments complies fully with the UK Waste Electrical & Electronic Equipment (WEEE) regulations 2013. We are a member of the B2B compliance scheme (Scheme Approval Number WEE/MP3338PT/SCH), which handle our WEEE obligations on our behalf. Grant Instruments have been issued with a unique registration number by the Environmental Agency, this reference number is WEE/GA0048TZ.

For information regarding WEEE collections in the UK please contact our B2B Compliance Scheme directly on 01691 676 124 or [www.b2bcompliance.org.uk](http://www.b2bcompliance.org.uk)

In the EU, Grant Instruments complies with WEEE Directive 2012/19/EU. Contact your local equipment supplier for WEEE collections.

### Restriction of substances hazardous to health (RoHS)

This product complies with the requirements of the UK Restriction of the Use of Certain Substances in Electrical and Electronic equipment Regulations 2012 and the EU RoHS Directive (2011/65/EC including 2015/863). This means the products are free of Lead and other hazardous substances covered by the directive.

### Electrical safety and electromagnetic compatibility

This product complies with the requirements of the UK Electrical Equipment (Safety) Regulations 2016 and the European Union Low Voltage Directive (2014/35/EC) for Electrical safety.

This product complies with the requirements of the UK Electromagnetic Compatibility Regulations 2016 and the European Union EMC directive (2014/30/EC).

## **Refrigerant F-Gas regulations**

The ecocool 150R is hermetically sealed equipment containing HC refrigerant R290

Refrigerant charge: 0.065 Kg

CO2 equivalent: 0.0002 Tonnes

Dispose of refrigeration according to local regulations

## **REACH Regulation**

This product does not contain any Substances of Very High Concern (SVHCs) at greater than 0.1% that have to be identified in accordance with Regulation (EC) No 1907/2006 and therefore does not have an entry in the SCIP database

## **Notes**

---



**Grant Instruments (Cambridge) Ltd**  
Shepreth  
Cambridgeshire  
SG8 6GB  
UK

Tel: +44 (0) 1763 260811  
[salesdesk@grantinstruments.com](mailto:salesdesk@grantinstruments.com)  
[www.grantinstruments.com](http://www.grantinstruments.com)

**Grant Instruments Europe B.V.**  
Strawinskylaan 411  
WTC, Tower A, 4th Floor  
1077 XX, AMSTERDAM  
THE NETHERLANDS

[grant@eu.grantinstruments.com](mailto:grant@eu.grantinstruments.com)

34894 V1 DMN U17